

1) Να κυκλώσεις το γράμμα τ

τ κ τ ν τ
λ τ π τ σ

2) Κυκλώνω ό,τι ξεκινάει απο τ

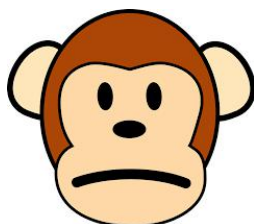
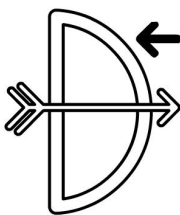
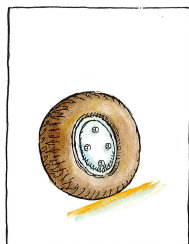

3) Διαβάζω συλλαβές:

τ α	τ ε	τ ο
τ ι	τ ω	τ η

3) Να κυκλώσεις τη συλλαβή τ α

τ α / κ ο / π α / τ α / τ ε

Να κυκλώσεις τη συλλαβή τ ι

τ ι / μ ε / τ ι / π ε / τ ι

Να κυκλώσεις τη συλλαβή τ ε



τ ε / π ι / τ ε / τ ο / τ ε

Να κυκλώσεις τη συλλαβή **τ ο**



τ ο / κ α / τ ο / μ ι / τ ο

4) Συμπληρώνω τις συλλαβές



τ α

	
..... ξ ί ψ ί

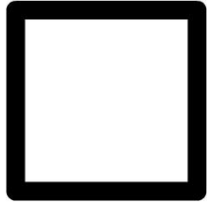
τ ε

		
.... τράδι οσσερατράγωνο

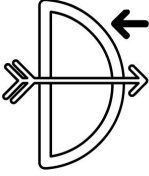
Τ Ο

		
.... π ιξ οσ τ

Τ Υ

		
.... ρ ί μ π α ν ο ρ ό π ι τ α

Τ Ι

	
.... μ ό ν ι γ ρ η ς

5)Κυκλώνω την πρώτη συλλαβή:

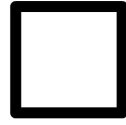

τη τε	τα το	τυ τε	τη τα
-------	-------	-------	-------



τι τω	το τυ	τε τω	το τα
-------	-------	-------	-------

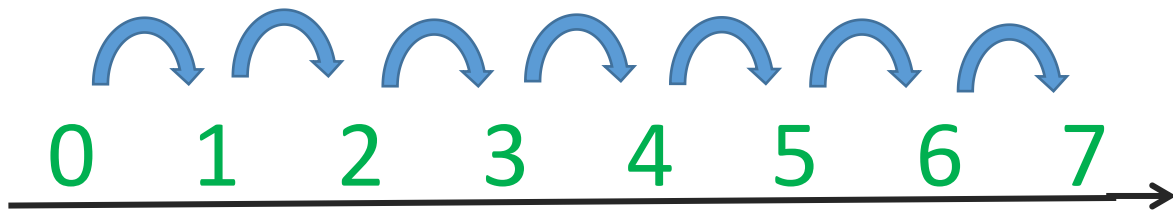

Μετράω τις φατσούλες και χρωματίζω τον αριθμό 7

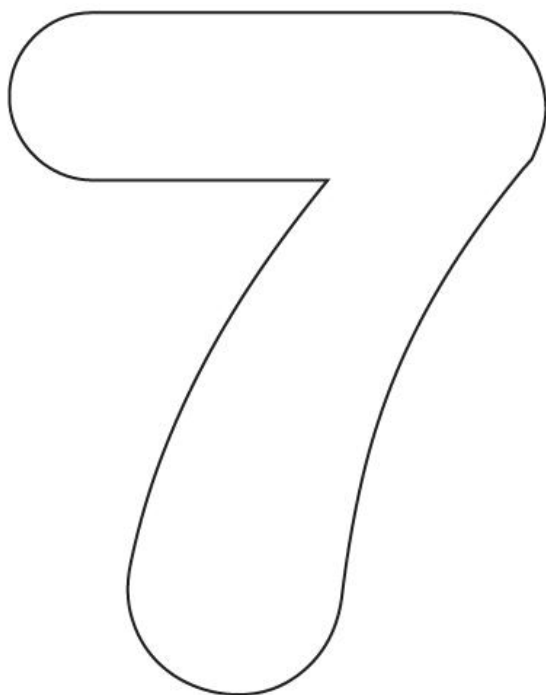

7	7	7	7	7	7



Πόσα ζώακια βρίσκονται μέσα στο κάθε κουτί; Γράψε τον αριθμό στον κύκλο(Εάν
θες συμβουλεύεσαι την αριθμογραμμή)

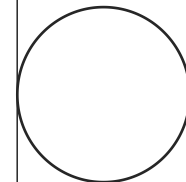
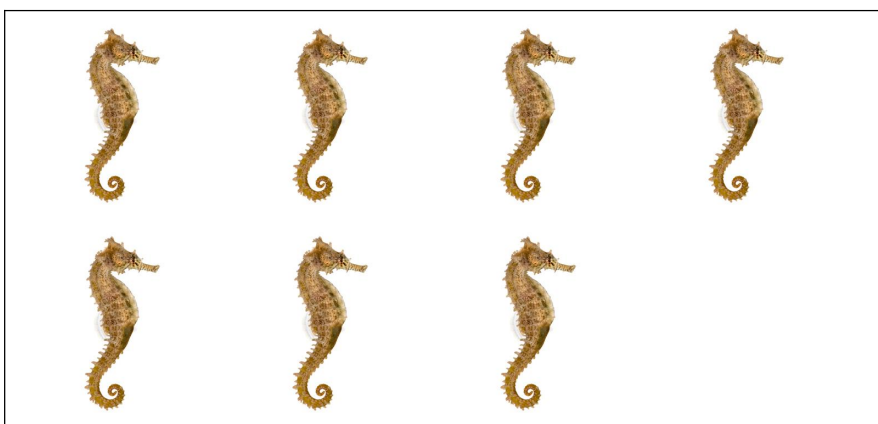
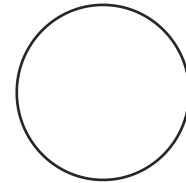
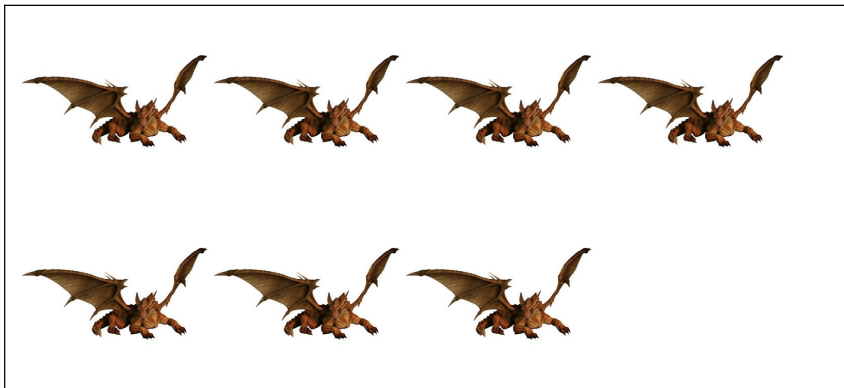
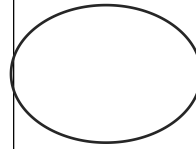
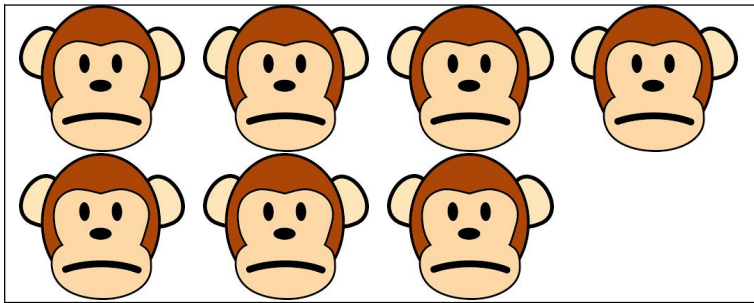

Να βρείς και να κυκλώσεις τον αριθμό 7

7 5 3 7

1 7 7 2

7 4 6 7

Χρωματίζω τα ίδια τετράγωνα όπως στο αριστερό σχέδιο

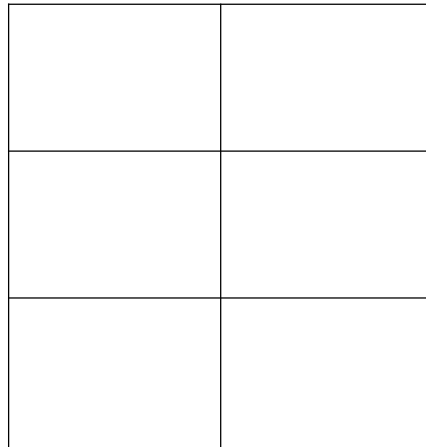
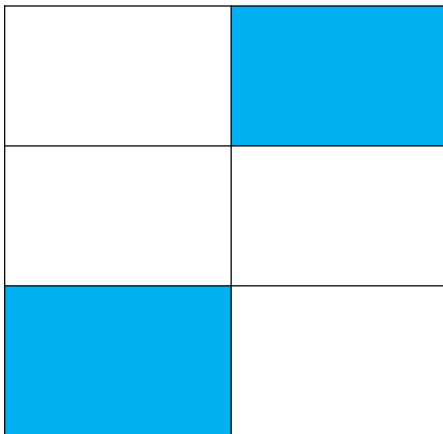



<https://efibarlou.blogspot.com/search/label/%CE%91%CF%81%CE%B9%CE%B8%CE%BC%CE%BF%CE%AF%20%CE%BA%CE%B1%CE%B9%20%CE%B6%CF%89%CE%B3%CF%81%CE%B1%CF%86%CE%B9%CE%BA%CE%AE>

